

P3PS850BH

Timing-Safe™ Peak EMI Reduction IC

Functional Description

P3PS850BH is a versatile, Timing-Safe peak EMI reduction IC. P3PS850BH accepts one input from an external reference, and locks on to it delivering a 1x Timing-Safe output clock. P3PS850BH has a Frequency Selection (FS) control that facilitates selecting one of the two operating frequency ranges. Refer to the *frequency Selection table*. The device has an SSEXTR pin to select different deviations depending upon the value of an external resistor connected at this pin to GND. P3PS850BH has an MR pin for selecting one of the two Modulation Rates. PD#/OE provides the Power Down option. Outputs will be tri-stated when power down is active.

P3PS850BH operates over a supply voltage range of 2.3 V to 3.6 V, and is available in an 8 Pin WDFN (2 mm x 2 mm) Package.

General Features

- 1x, LVCMOS Timing-Safe Peak EMI Reduction
- Input Clock Frequency:
 - ◆ 18 MHz – 72 MHz
- Output Clock Frequency(Timing-Safe):
 - ◆ 18 MHz – 72 MHz
- Analog Frequency Deviation Selection
- Two different Modulation Rate Selection
- Power Down option for Power Save
- Output buffer strength: 16 mA
- Supply Voltage: 2.3 V – 3.6 V
- 8 pin WDFN 2 mm x 2 mm, (TDFN) Package
- These Devices are Pb-Free, Halogen Free/BFR Free and are RoHS Compliant

Application

- P3PS850BH is targeted for use in consumer electronic applications like mobile phones, Camera modules, MFP and DPF.



ON Semiconductor®

<http://onsemi.com>

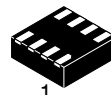

WDFN8
CASE 511AQ

MARKING DIAGRAMS

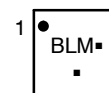

- BL = Specific Device Code
- M = Date Code
- = Pb-Free Device

PIN CONFIGURATION

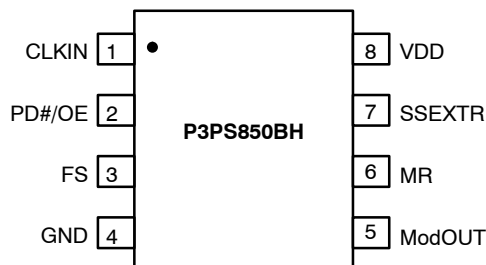

ORDERING INFORMATION

See detailed ordering and shipping information in the package dimensions section on page 11 of this data sheet.

P3PS850BH

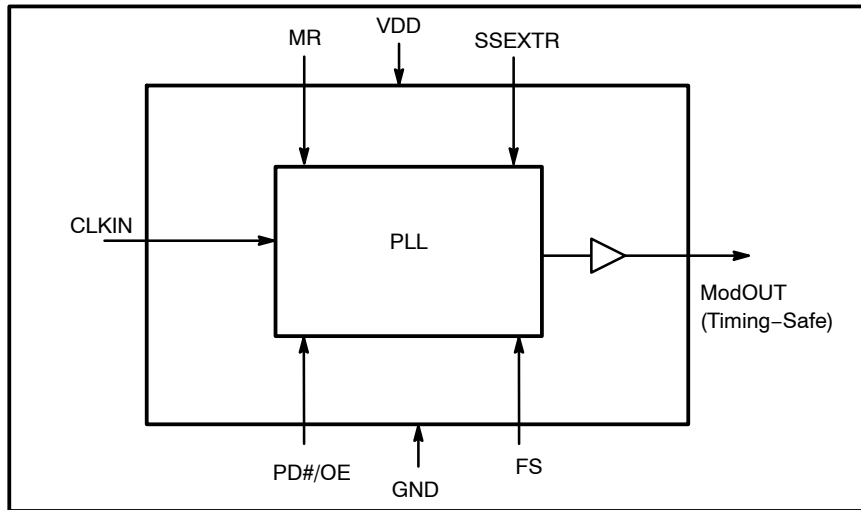

Figure 1. Block Diagram

Table 1. PIN DESCRIPTION

Pin#	Pin Name	Type	Description
1	CLKIN	I	External reference Clock input.
2	PD# / OE	I	Power Down. Pull LOW to enable Power Down. Outputs will be tri-stated when power down is enabled. Pull HIGH to disable power down and enable output. NO default state.
3	FS	I	Frequency Select .NO default state. Refer to the <i>Frequency Selection</i> table
4	GND	P	Ground
5	ModOUT	O	Buffered modulated Timing-Safe clock output
6	MR	I	Modulation Rate Select. When LOW, selects Low Modulation Rate. Selects High Modulation Rate when pulled HIGH. Has an internal pull-up resistor.
7	SSEXTR	I	Analog Deviation Selection through external resistor to GND.
8	VDD	P	Supply Voltage

Table 2. FREQUENCY SELECTION TABLE

FS	Frequency (MHz)
0	18–36
1	36–72

Table 3. OPERATING CONDITIONS

Symbol	Parameter	Min	Max	Unit
V _{DD}	Supply Voltage	2.3	3.6	V
T _A	Operating Temperature	-20	+85	°C
C _L	Load Capacitance		15	pF
C _{IN}	Input Capacitance		7	pF

P3PS850BH

Table 4. ABSOLUTE MAXIMUM RATING

Symbol	Parameter	Rating	Unit
V_{DD}, V_{IN}	Voltage on any input pin with respect to Ground	-0.5 to +4.6	V
T_{STG}	Storage temperature	-65 to +125	°C
T_s	Max. Soldering Temperature (10 sec)	260	°C
T_J	Junction Temperature	150	°C
T_{DV}	Static Discharge Voltage (As per JEDEC STD22-A114-B)	2	kV

Stresses exceeding Maximum Ratings may damage the device. Maximum Ratings are stress ratings only. Functional operation above the Recommended Operating Conditions is not implied. Extended exposure to stresses above the Recommended Operating Conditions may affect device reliability.

Table 5. DC ELECTRICAL CHARACTERISTICS

Symbol	Parameter	Test Conditions	Min	Typ	Max	Unit
V_{DD}	Supply Voltage		2.3	2.7	3.6	V
V_{IH}	Input HIGH Voltage		$0.65 * V_{DD}$			V
V_{IL}	Input LOW Voltage				$0.35 * V_{DD}$	V
I_{IH}	Input HIGH Current	$V_{IN} = V_{DD}$			10	μA
I_{IL}	Input LOW Current	$V_{IN} = 0$ V for MR pin			10	μA
V_{OH}	Output HIGH Voltage	$I_{OH} = -16$ mA	$0.75 * V_{DD}$			V
V_{OL}	Output LOW Voltage	$I_{OL} = 16$ mA			$0.25 * V_{DD}$	V
I_{CC}	Static Supply Current	PD#/OE pin pulled to GND			10	μA
I_{DD}	Dynamic Supply Current	Unloaded Output	FS = 0, @ 18 MHz	6	10	mA
			FS = 0, @ 24 MHz	7	12	
			FS = 0, @ 36 MHz	10	17	
			FS = 1, @ 36 MHz	9	14	
			FS = 1, @ 48 MHz	11	19	
			FS = 1, @ 72 MHz	16	28	
Z_o	Output Impedance			13		Ω

Table 6. AC ELECTRICAL CHARACTERISTICS

Parameter	Test Conditions	Min	Typ	Max	Unit
Input Frequency	FS = 0	18	24	36	MHz
	FS = 1	36	48	72	
ModOUT	FS = 0	18	24	36	MHz
	FS = 1	36	48	72	
Duty Cycle (Note 1 and 2)	Measured at $V_{DD} / 2$	45	50	55	%
Rise Time (Note 1 and 2)	Measured between 20% to 80%		0.8	1.2	ns
Fall Time (Note 1 and 2)	Measured between 80% to 20%		0.8	1.2	ns

1. All parameters are specified with 15 pF loaded output.
2. Parameter is guaranteed by design and characterization. Not 100% tested in production.

P3PS850BH

Table 6. AC ELECTRICAL CHARACTERISTICS

Parameter	Test Conditions	Min	Typ	Max	Unit	
Cycle-to-Cycle Jitter (Note 2)	Unloaded output with SSEXTR pin OPEN	FS = 0, 18 MHz		± 250	± 350	ps
		FS = 0, 24 MHz		± 150	± 225	
		FS = 0, 36 MHz		± 75	± 125	
		FS = 1, 36 MHz		± 150	± 200	
		FS = 1, 48 MHz		± 100	± 150	
		FS = 1, 72 MHz		± 75	± 125	
PLL Lock Time (Note 2)	Stable power supply, valid clock presented on CLKIN pin, PD# toggled from Low to High			1	ms	

1. All parameters are specified with 15 pF loaded output.
2. Parameter is guaranteed by design and characterization. Not 100% tested in production.

DEVIATION VERSUS SSEXTR RESISTANCE CHARTS

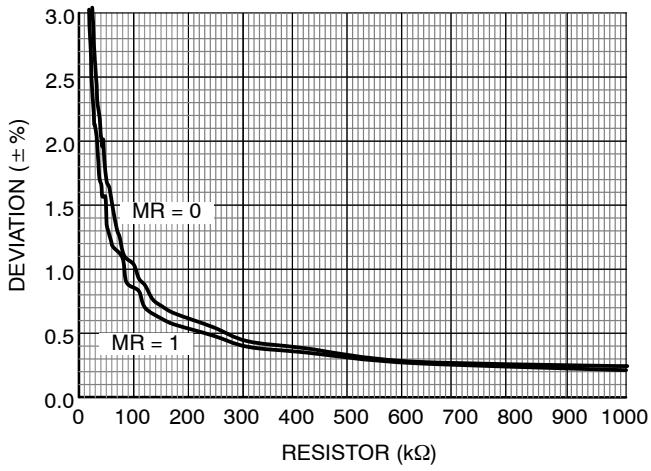

Figure 2. Deviation vs. SSEXTR @ 18 MHz (FS = 0)

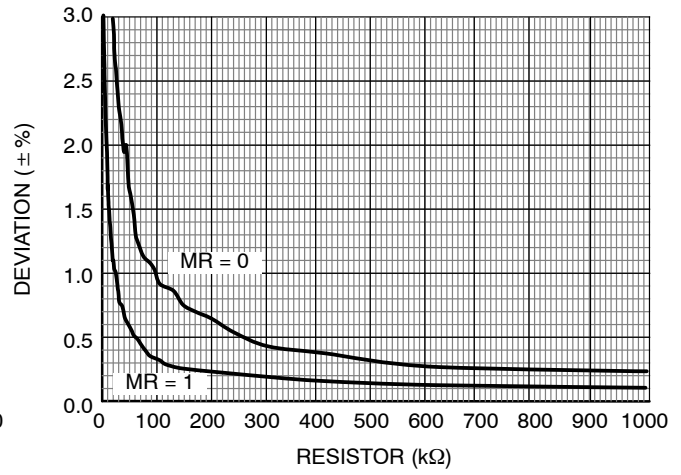

Figure 3. Deviation vs. SSEXTR @ 24 MHz (FS = 0)

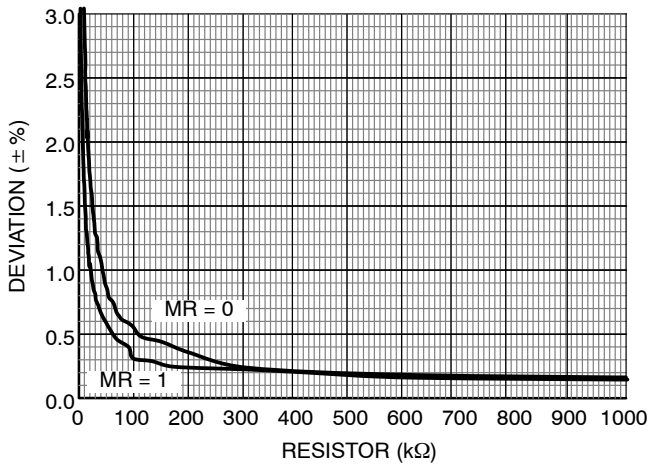

Figure 4. Deviation vs. SSEXTR @ 27 MHz (FS = 0)

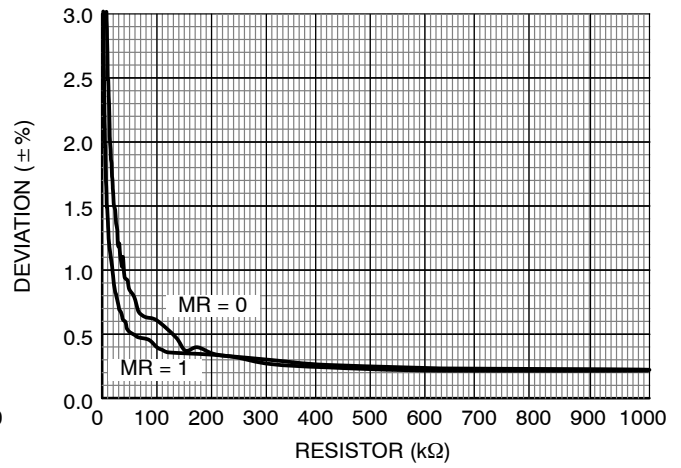

Figure 5. Deviation vs. SSEXTR @ 30 MHz (FS = 0)

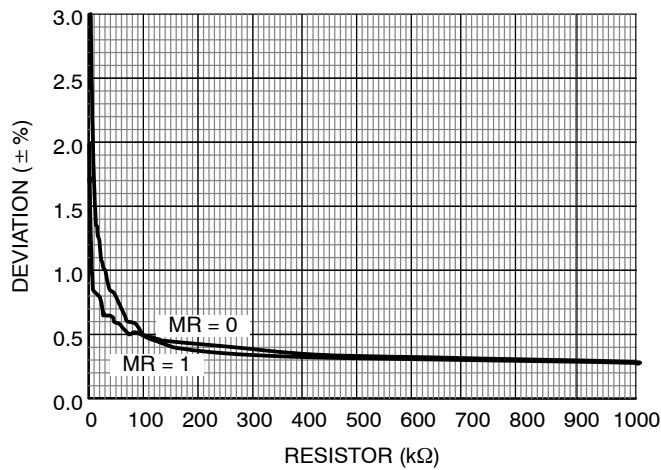

Figure 6. Deviation vs. SSEXTR @ 36 MHz (FS = 0)

DEVIATION VERSUS SSEXTR RESISTANCE CHARTS

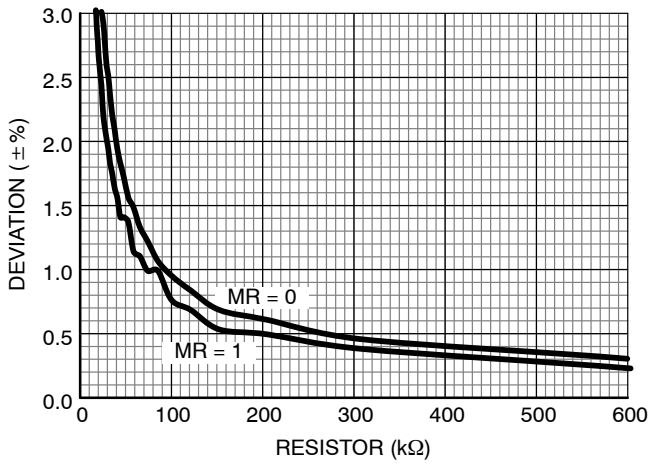

Figure 7. Deviation vs. SSEXTR @ 36 MHz (FS = 1)

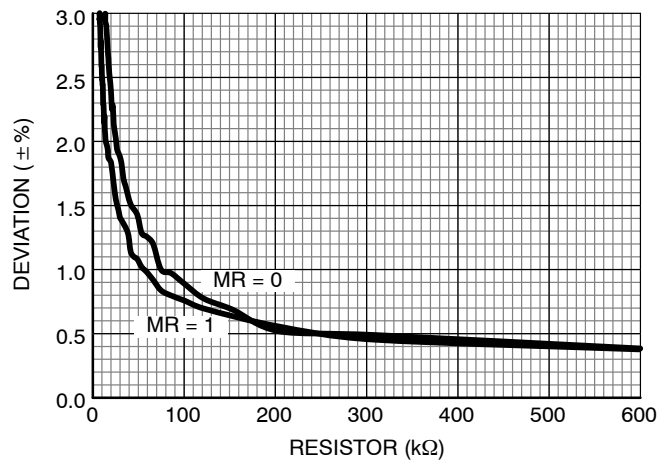

Figure 8. Deviation vs. SSEXTR @ 48 MHz (FS = 1)

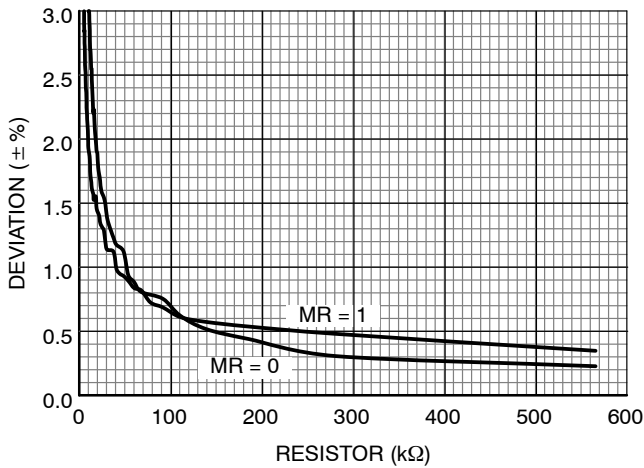

Figure 9. Deviation vs. SSEXTR @ 54 MHz (FS = 1)

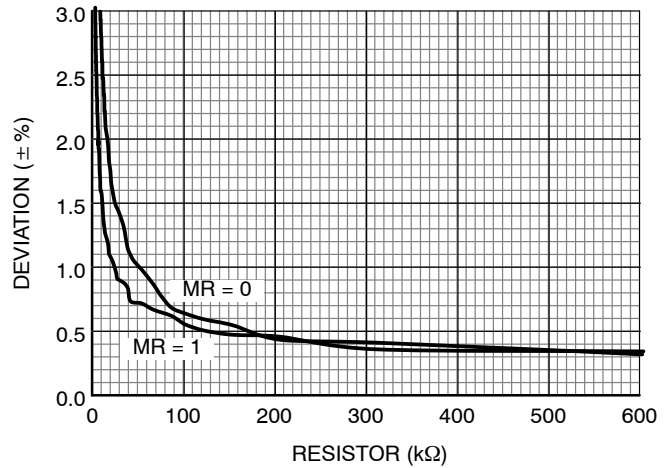

Figure 10. Deviation vs. SSEXTR @ 60 MHz (FS = 1)

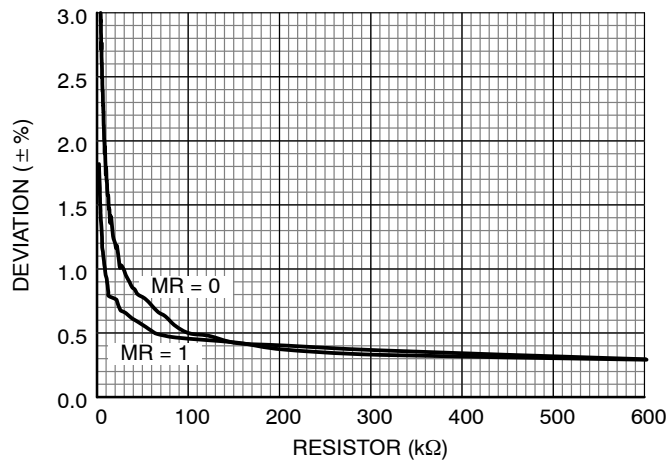

Figure 11. Deviation vs. SSEXTR @ 72 MHz (FS = 1)

TSKEW VERSUS SSEXTR RESISTANCE CHARTS

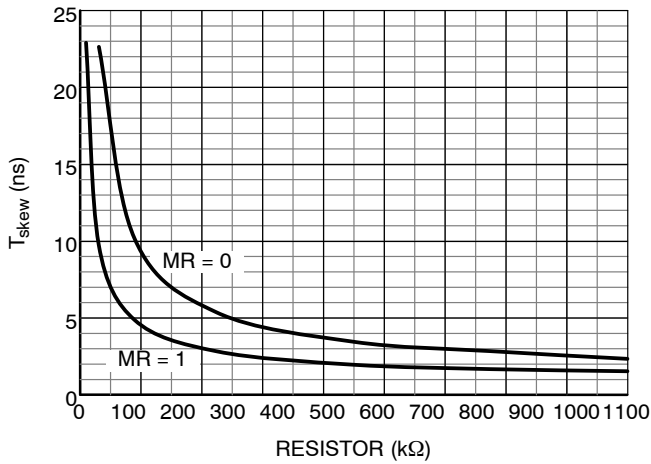

Figure 12. Tskew vs. SSEXTR @ 18 MHz
(FS = 0)

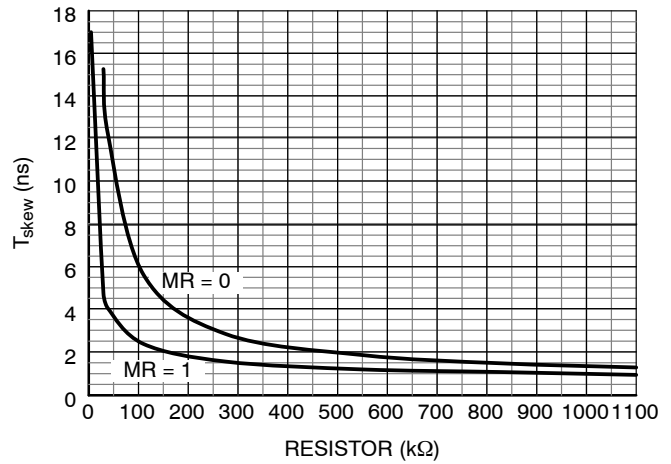

Figure 13. Tskew vs. SSEXTR @ 24 MHz
(FS = 0)

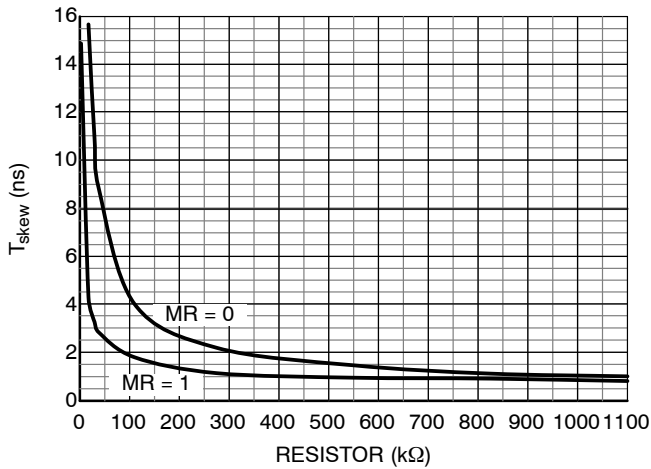

Figure 14. Tskew vs. SSEXTR @ 27 MHz
(FS = 0)

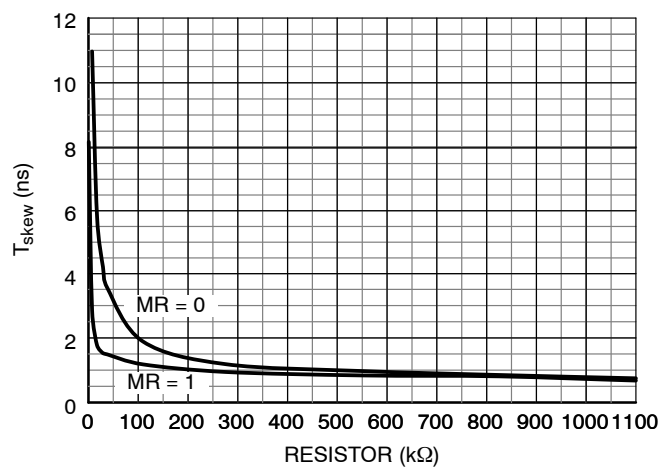

Figure 15. Tskew vs. SSEXTR @ 36 MHz
(FS = 0)

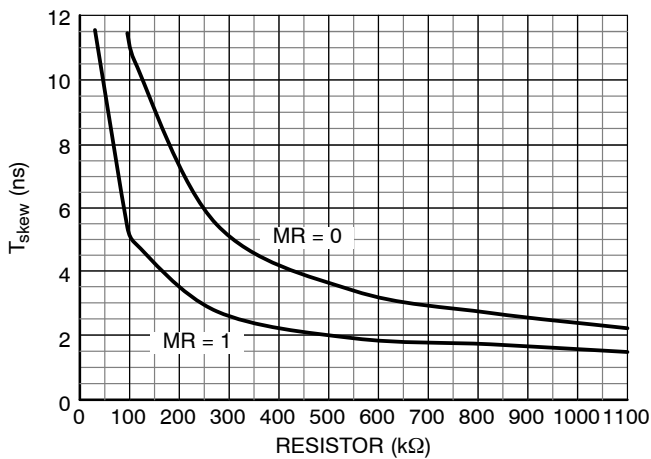

Figure 16. Tskew vs. SSEXTR @ 36 MHz
(FS = 1)

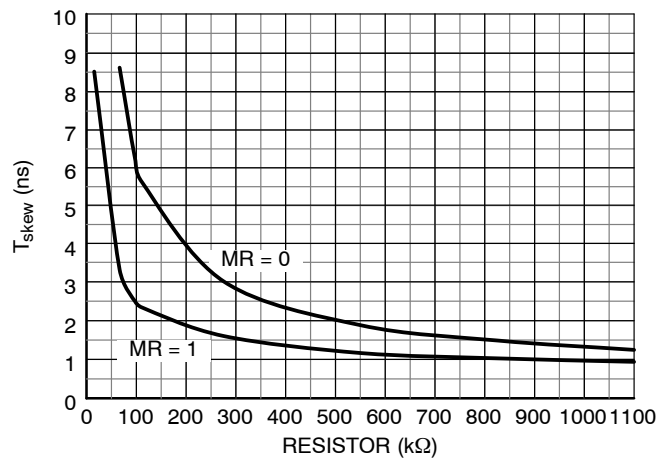

Figure 17. Tskew vs. SSEXTR @ 48 MHz
(FS = 1)

TSKEW VERSUS SSEXTR RESISTANCE CHARTS

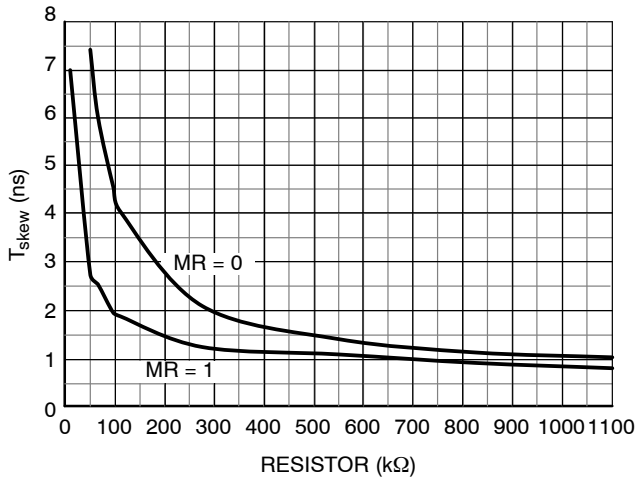

Figure 18. Tskew vs. SSEXTR @ 54 MHz (FS = 1)

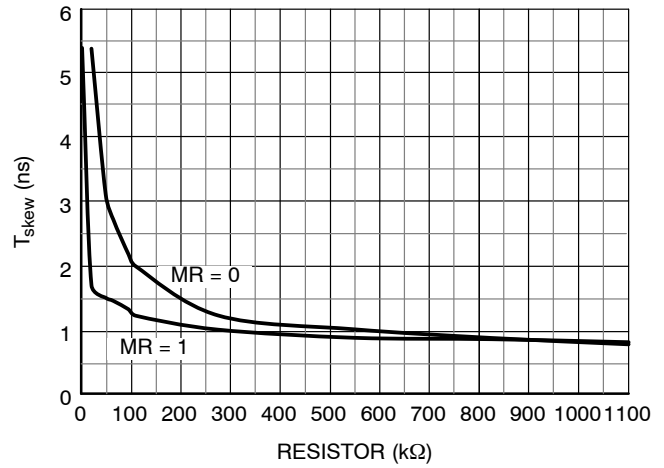

Figure 19. Tskew vs. SSEXTR @ 72 MHz (FS = 1)

MINIMUM SSEXTR RESISTANCE VERSUS FREQUENCY(FOR TIMING-SAFE OPERATION) CHARTS

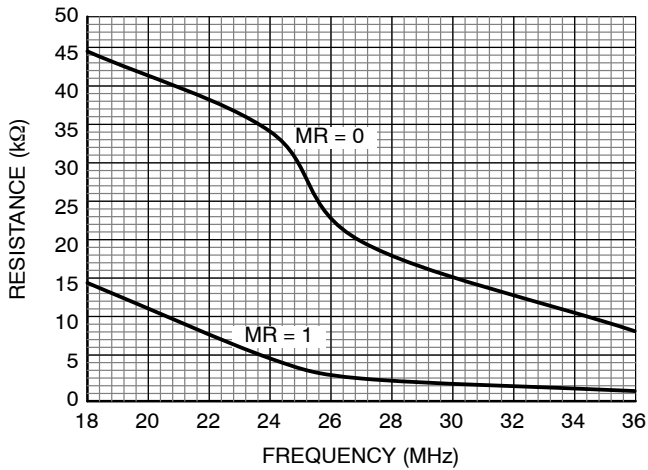

Figure 20. Frequency vs. Resistance (FS = 0)

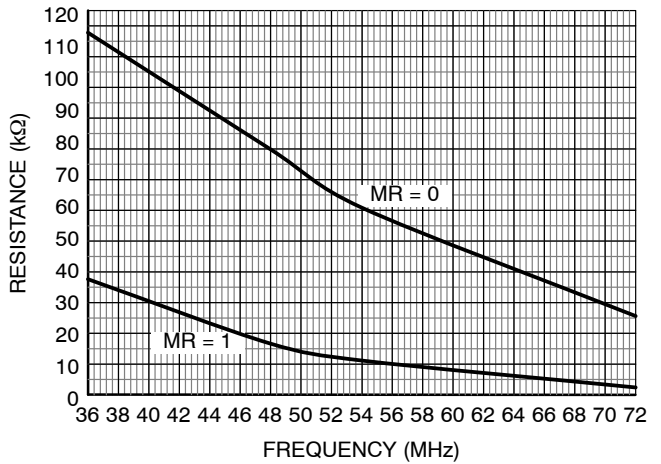

Figure 21. Frequency vs. Resistance (FS = 1)

NOTE: Device-to-Device variation of Deviation and Tskew is $\pm 10\%$

P3PS850BH

SWITCHING WAVEFORMS

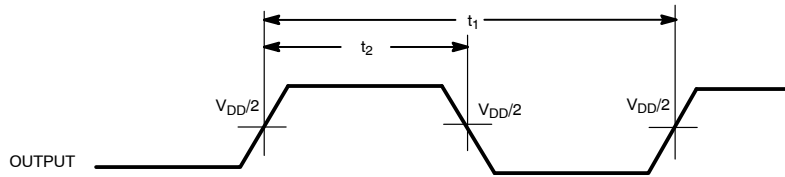

Figure 22. Duty Cycle Timing

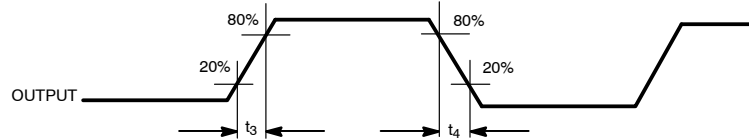
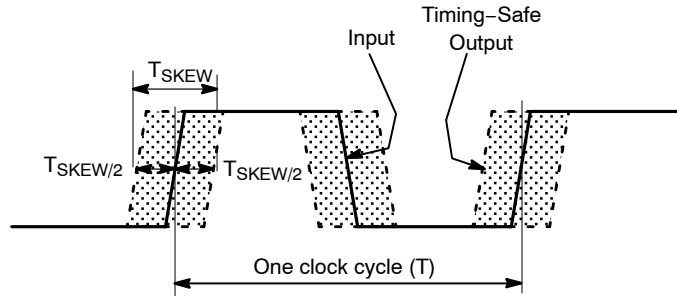

Figure 23. Output Rise/Fall Time



T_{SKEW} represents input-output skew when spread spectrum is ON
 For example, $T_{SKEW} / 2 = 0.20 * T$ for an Input clock of 24 MHz, translates in to
 $(1/24 \text{ MHz}) * 0.20 = 8.33 \text{ ns}$

Figure 24. Input-Output Skew

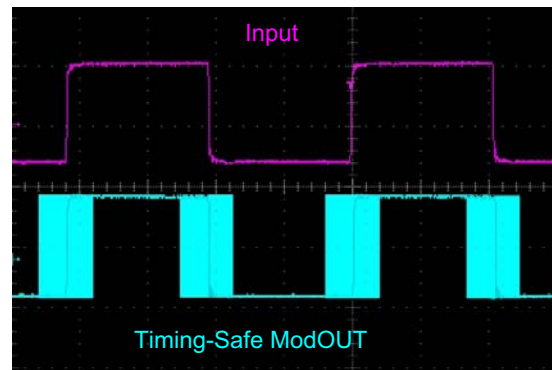
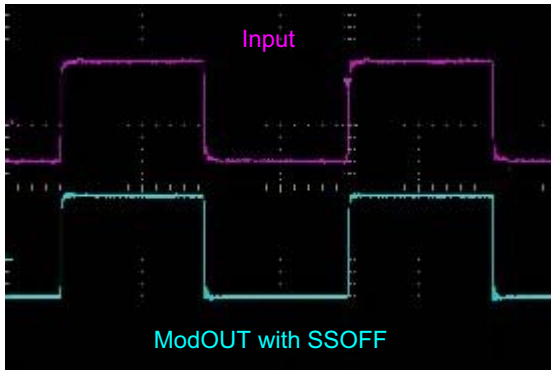
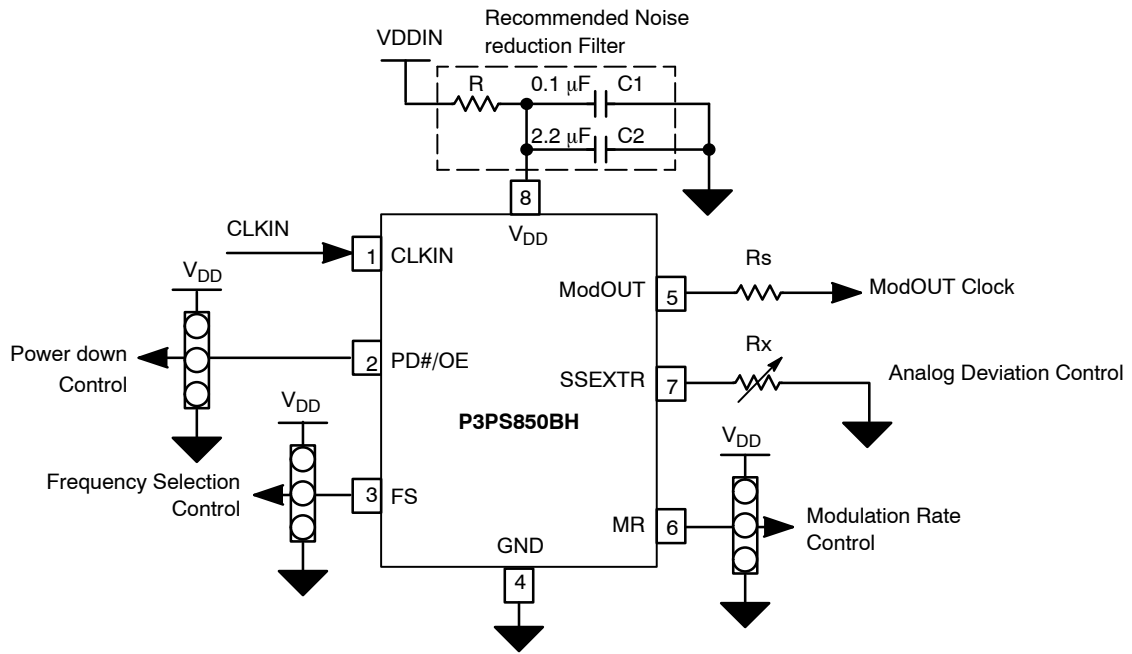

Figure 25. Typical Example of Timing-Safe Waveform

P3PS850BH



NOTE: Refer Pin Description table for Functionality details.

Figure 26. Typical Application Schematic

P3PS850BH

PCB Layout Recommendation

For optimum device performance, following guidelines are recommended.

- Dedicated VDD and GND planes.
 - The device must be isolated from system power supply noise. A 0.1 μF and a 2.2 μF decoupling capacitor should be mounted on the component side of the board as close to the VDD pin as possible. No vias should be used between the decoupling capacitor and VDD pin. The PCB trace to VDD pin and the ground via should be kept as short as possible. All the VDD pins should have decoupling capacitors.
 - In an optimum layout all components are on the same side of the board, minimizing vias through other signal layers.
- A typical layout is shown in Figure 27.

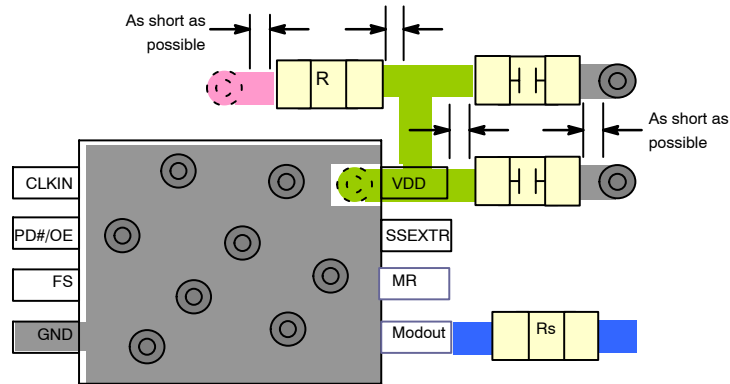

Figure 27.

ORDERING INFORMATION

Part Number	Top Marking	Temperature	Package Type	Shipping†
P3PS850BHG-08CR	BL	-20°C to +85°C	8-Pin (2 mm x 2 mm) WDFN(TDFN) (Pb-Free)	Tape & Reel

†For information on tape and reel specifications, including part orientation and tape sizes, please refer to our Tape and Reel Packaging Specifications Brochure, BRD8011/D.

*A "microdot" placed at the end of last row of marking or just below the last row toward the center of package indicates Pb-Free.

P3PS850BH

PACKAGE DIMENSIONS

WDFN8 2x2, 0.5P
CASE 511AQ-01
ISSUE A

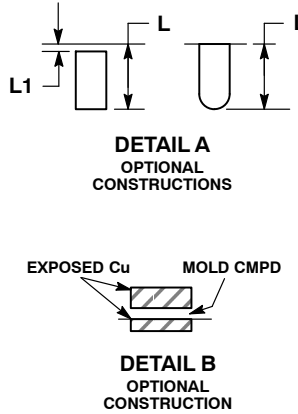
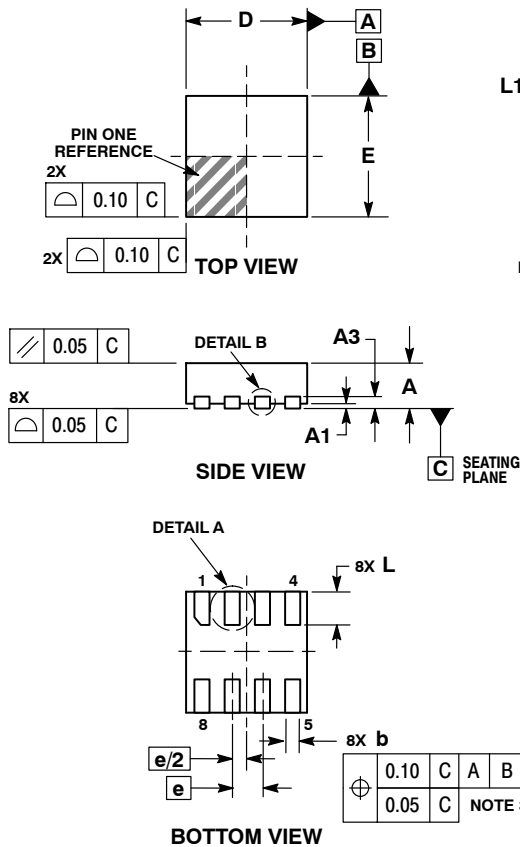

- NOTES:
1. DIMENSIONING AND TOLERANCING PER ASME Y14.5M, 1994.
 2. CONTROLLING DIMENSION: MILLIMETERS.
 3. DIMENSION b APPLIES TO PLATED TERMINAL AND IS MEASURED BETWEEN 0.15 AND 0.30mm FROM TERMINAL.

DIM	MILLIMETERS	
	MIN	MAX
A	0.70	0.80
A1	0.00	0.05
A3	0.20 REF	
b	0.20	0.30
D	2.00 BSC	
E	2.00 BSC	
e	0.50 BSC	
L	0.50	0.60
L1	---	0.15

RECOMMENDED SOLDERING FOOTPRINT*

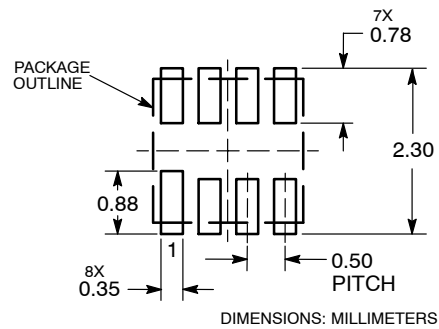

*For additional information on our Pb-Free strategy and soldering details, please download the ON Semiconductor Soldering and Mounting Techniques Reference Manual, SOLDERRM/D.

Timing-Safe is a trademark of Semiconductor Components Industries, LLC (SCILLC).

ON Semiconductor and are registered trademarks of Semiconductor Components Industries, LLC (SCILLC). SCILLC reserves the right to make changes without further notice to any products herein. SCILLC makes no warranty, representation or guarantee regarding the suitability of its products for any particular purpose, nor does SCILLC assume any liability arising out of the application or use of any product or circuit, and specifically disclaims any and all liability, including without limitation special, consequential or incidental damages. "Typical" parameters which may be provided in SCILLC data sheets and/or specifications can and do vary in different applications and actual performance may vary over time. All operating parameters, including "Typicals" must be validated for each customer application by customer's technical experts. SCILLC does not convey any license under its patent rights nor the rights of others. SCILLC products are not designed, intended, or authorized for use as components in systems intended for surgical implant into the body, or other applications intended to support or sustain life, or for any other application in which the failure of the SCILLC product could create a situation where personal injury or death may occur. Should Buyer purchase or use SCILLC products for any such unintended or unauthorized application, Buyer shall indemnify and hold SCILLC and its officers, employees, subsidiaries, affiliates, and distributors harmless against all claims, costs, damages, and expenses, and reasonable attorney fees arising out of, directly or indirectly, any claim of personal injury or death associated with such unintended or unauthorized use, even if such claim alleges that SCILLC was negligent regarding the design or manufacture of the part. SCILLC is an Equal Opportunity/Affirmative Action Employer. This literature is subject to all applicable copyright laws and is not for resale in any manner.

PUBLICATION ORDERING INFORMATION

LITERATURE FULFILLMENT:
Literature Distribution Center for ON Semiconductor
P.O. Box 5163, Denver, Colorado 80217 USA
Phone: 303-675-2175 or 800-344-3860 Toll Free USA/Canada
Fax: 303-675-2176 or 800-344-3867 Toll Free USA/Canada
Email: orderlit@onsemi.com

N. American Technical Support: 800-282-9855 Toll Free
USA/Canada
Europe, Middle East and Africa Technical Support:
Phone: 421 33 790 2910
Japan Customer Focus Center
Phone: 81-3-5773-3850

ON Semiconductor Website: www.onsemi.com
Order Literature: <http://www.onsemi.com/orderlit>
For additional information, please contact your local Sales Representative